

G108

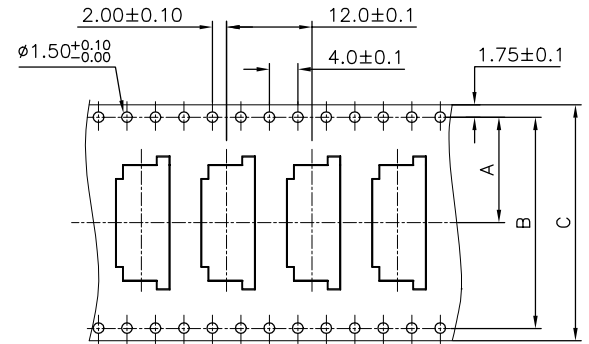

双边孔

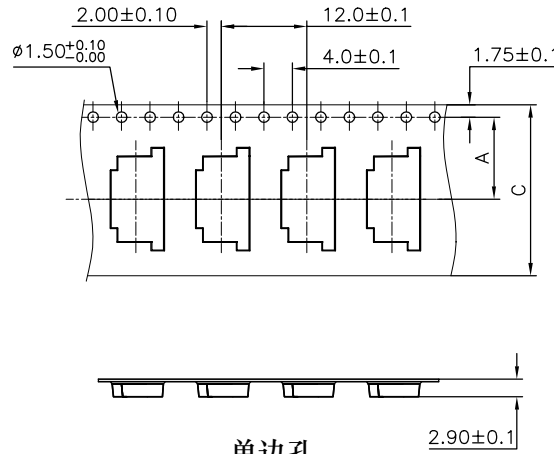
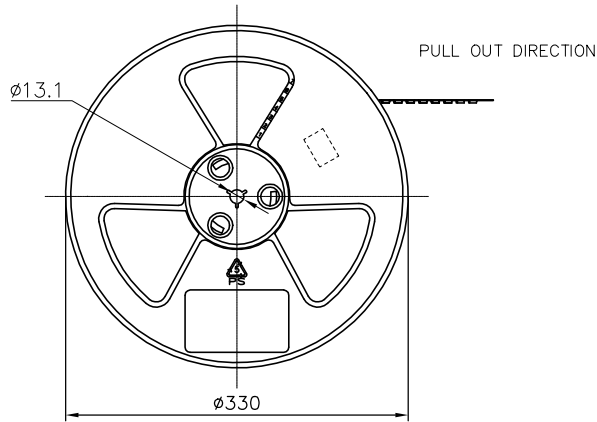
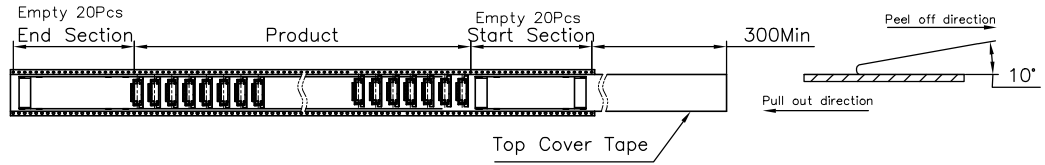
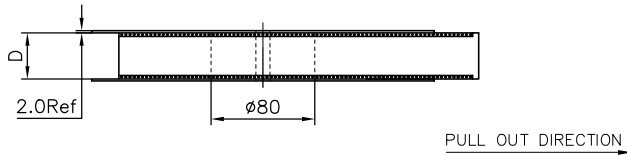
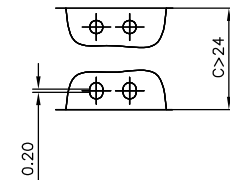

DIM TABLE : ①

PIN NO.	DIM A	DIM B	DIM C	DIM D
4~10	11.50±0.10	-- 单边孔	24.0±0.30	25.5±0.30
11~14	14.20±0.10	28.40±0.10	32.0±0.30	33.5±0.30
15~25	20.20±0.15	40.40±0.10	44.0±0.30	45.5±0.30
26~30	26.20±0.15	52.40±0.10	56.0±0.30	57.5±0.30

Note:  
 1.Number of connectors:1500 pcs/Reel  
 2.Peeling off force of top tape 10g~100g

DRAWING:  
Frank

GENERAL TOLERANCE  
 .X:=±0.30 .X\*:=±5°  
 .XX:=±0.20 .XX\*:=±3°  
 .XXX:=±0.10 .XXX\*:=±1°



**CHIN-BAN**  
 electronics (H.K) co., ltd

CHECKED:  
Tony

UNIT: MM

PROJECTION:

DESCRIPTION:  
1.0mm PITCH FPC H=2.5 (Upper/Bottom) Packing

APPROVAL:  
yang jie

SCALE: 1/1

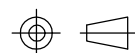

PART NO: F4XXXU-XXX3-F

REV: 2.0

NO.	DATE	DESCRIPTION	APPROVAL
	2017.04.22	DRAWING UPDATE ①	Frank

SHEET: 1/1

DRAWING NO:

SIZE: A4