

# ROHS+REACH

NO.	DATE	DESCRIPTION	APPROVAL
X0	2017.08.03	NEW	Huyatao

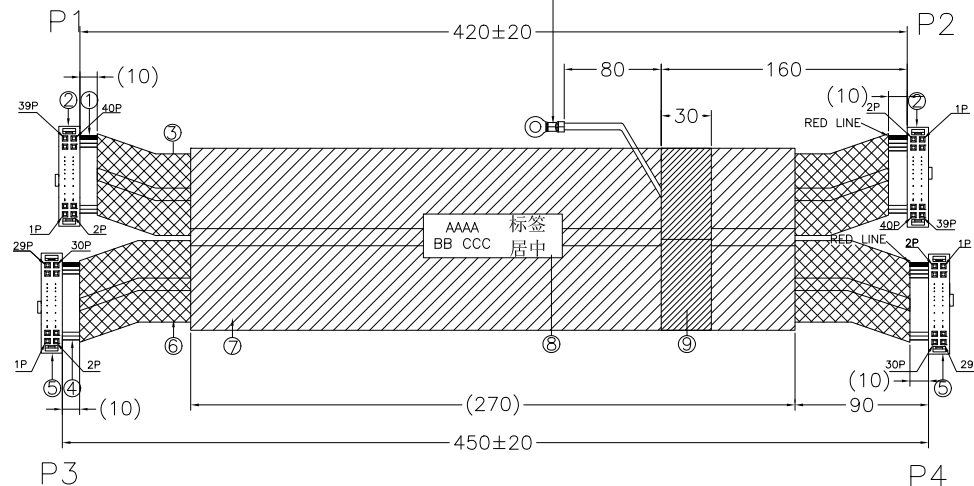
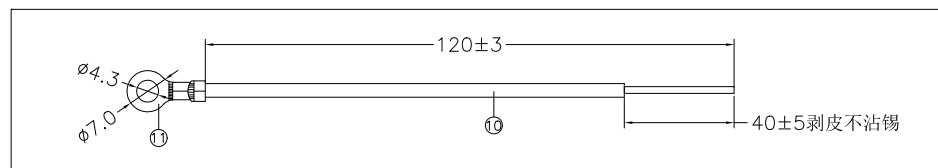

技术要求:(▲为重点管控)

- ▲1、100%测试导通，断路、短路等。  
导通电阻：1Ω MAX  
绝缘电阻：10MΩ MIN
- ▲2、配插力度:插入力100g/pin，拔出力 10g-80g/pin
- ▲3、耐久性能 500次
- ▲4、配插牛角时，无变形，退扣现象。
- 5、线材颜色均匀，表面无破损、划伤、脏污、变形等缺陷。  
连接器表面光滑平整，无毛刺、损伤、变形、脏污。
- 6、标签贴在导电胶布上，保持标签整洁，干净，  
四周不能有起翘、打折、打皱现象
- 7、圆环端子线粘贴牢固，不可掉落

⑫	PE Film	PE膜	1PCS	
⑪	Terminal	R TIPE TERMINAL D:4.3*W:7.0*T0.4mm	1PCS	
⑩	WIRE	UL1007 24AWG OD:1.4mm Black	1PCS	
⑨	TUBE	导电胶布 L30*W150mm	1PCS	
⑧	LABEL	合成纸电线胶L40*15mm白色	1PCS	
⑦	TUBE	导电胶布 L270*W120mm	1PCS	
⑥	TUBE	醋酸胶布 L430*W50mm 黑色	1PCS	
⑤	IDC	1.27x1.27 IDC 30Pin Brass With Bump	2SETS	
④	WIRE	FLAT CABLE UL2678 30AWG(7/0.10TS)x30PIN PITCH:0.635 GREY ROWS WITH RED SIDE	1PCS	
③	TUBE	醋酸胶布 L400*W60mm 黑色	1PCS	
②	IDC	1.27x1.27 IDC 40Pin Brass With Bump	2SETS	
①	WIRE	FLAT CABLE UL2678 30AWG(7/0.10TS)x40PIN PITCH:0.635 GREY ROWS WITH RED SIDE	1PCS	
Item	Title	Specification	Q'TY	Note

DRAWING:  
Huyatao

CHECKED:  
Yangjie

APPROVAL:

TOLERANCE  
.X:=±0.50  
.XX:=±0.30  
.XXX:=±0.10



UNIT: MM  
SCALE: N/A  
SHEET: 1/2



**CHIN-BAN**  
electronics (H.K) co., ltd

DESCRIPTION:  
CABLE FLAT MAIN BOARD - UI BOARD

CUSTOMER NO:	REV: X0
PART NO: 4403-70GR-L450-S82	UK
CUSTOMER P/N:	SIZE: A4
LUM P/N:	

# ROHS+REACH

NO.	DATE	DESCRIPTION	APPROVAL
X0	2017.08.03	NEW	Huyatao

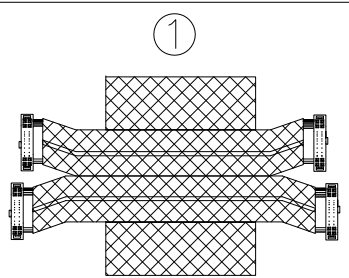

①

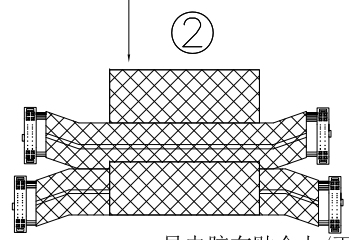

②

导电胶布贴合上/下边  
先后顺序暂无要求

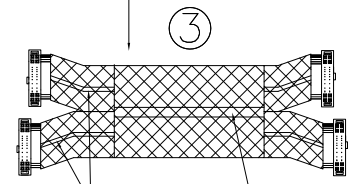

③

醋酸胶布贴合面      导电胶布贴合面

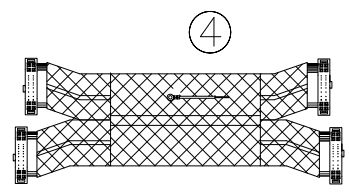

④

圆环端子线横向摆在  
在40Pin的IDC线中间

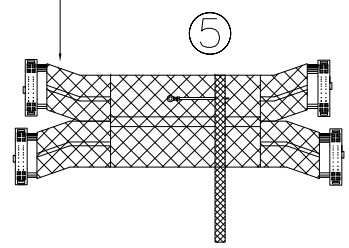

⑤

将30mm宽的导电布贴在  
圆环端子尾部铜丝处，铜丝露出10mm

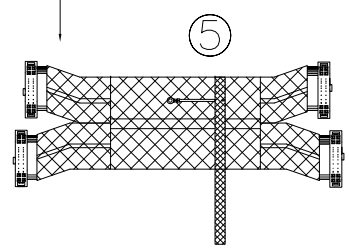

⑤

将圆环端子线尾部露出的10mm铜丝  
反折到导电布上

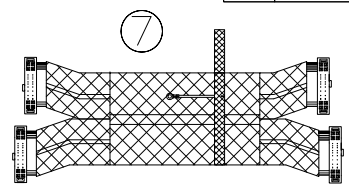

⑦

30mm宽导电布绕整条线一圈

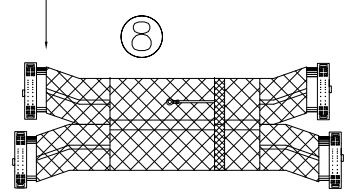

⑧

30mm宽导电布将反折后的铜丝包裹住

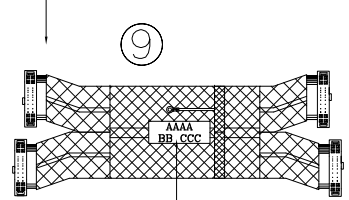

⑨

标签置于导电胶布缝合面处且居中处理

Connection		Connection	
P1	P2	P3	P4
40 — red — 1	30 — red — 1	39 — gray — 2	29 — gray — 2
39 — gray — 2	29 — gray — 2	38 — gray — 3	28 — gray — 3
2 — gray — 39	2 — gray — 29	1 — gray — 40	1 — gray — 30

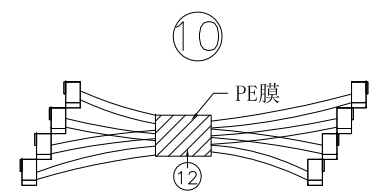

⑩

包装图(10pcs/扎)

Item	Title	Specification	Q'TY	Note
1				
2				
3				
4				

DRAWING: Huyatao	TOLERANCE .X:±0.50 .XX:±0.30 .XXX:±0.10		
CHECKED: Yangjie			
APPROVAL:	UNIT: MM	DESCRIPTION: CABLE FLAT MAIN BOARD - UI BOARD	REV: X0
	SCALE: N/A	CUSTOMER NO:	UK
	SHEET: 2/2	PART NO: 4403-70GR-L450-S82	SIZE: A4
		CUSTOMER P/N: 6-01.13.037326	
		LUM P/N:	